

COMBINATION LEVER CRS 1 RH & 1 LH REQD  
 RH LEVER IS SHOWN LH WILL HAVE CLEAR ANGLE ON  
 OPOSITE SIDE

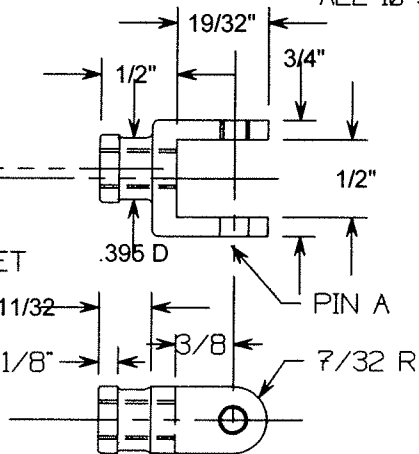

VALVE ROD FITTING  
 CRS 2 REQD

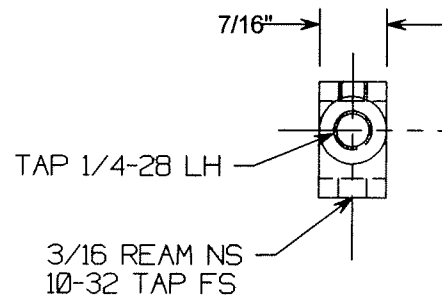
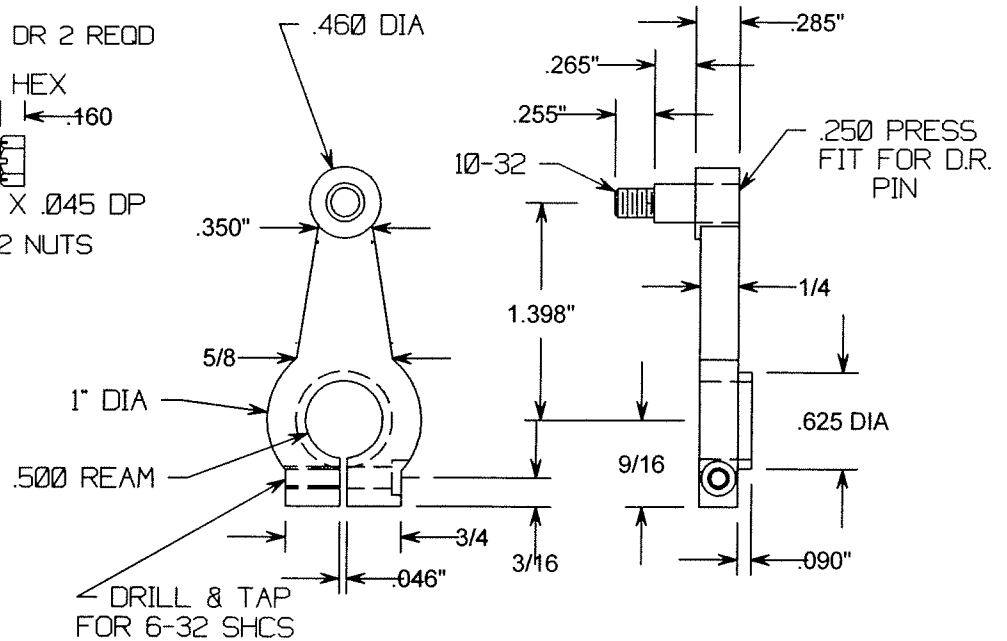
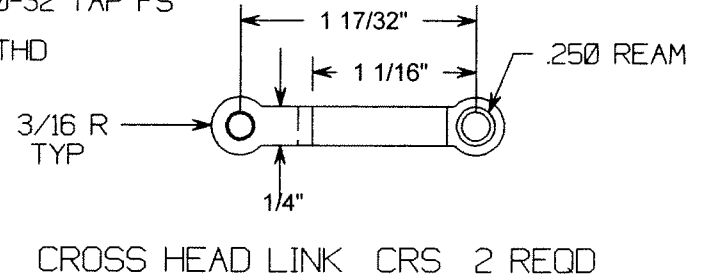
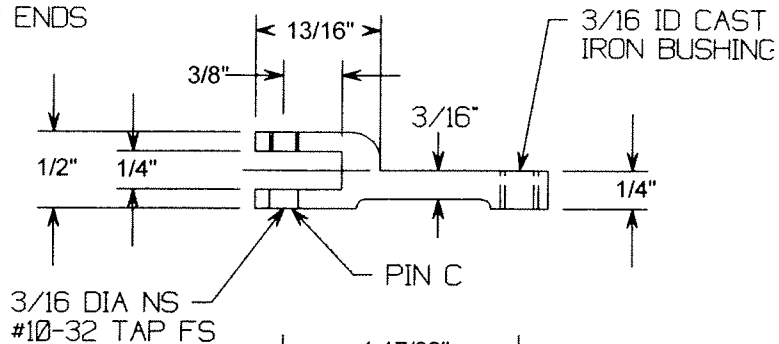
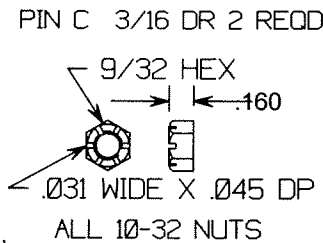
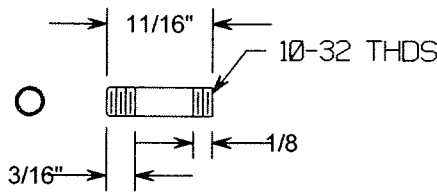
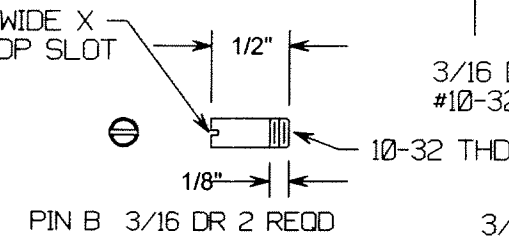
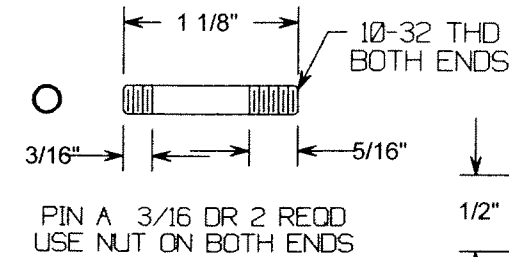

RETURN CRANK CRS 2 REQD

VALVE GEAR DETAILS  
 1 1/2" LIGHT MOGUL  
 SHEET 23