

CYLINDER DETAILS
1 1/2" LIGHT MOGUL
SHEET 4

DRAWN BY PAUL F BRIEN MARCH 1985

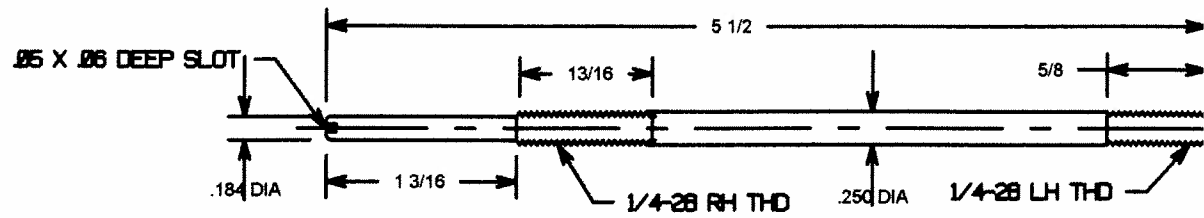

VALVE ROD SS 2 REOD

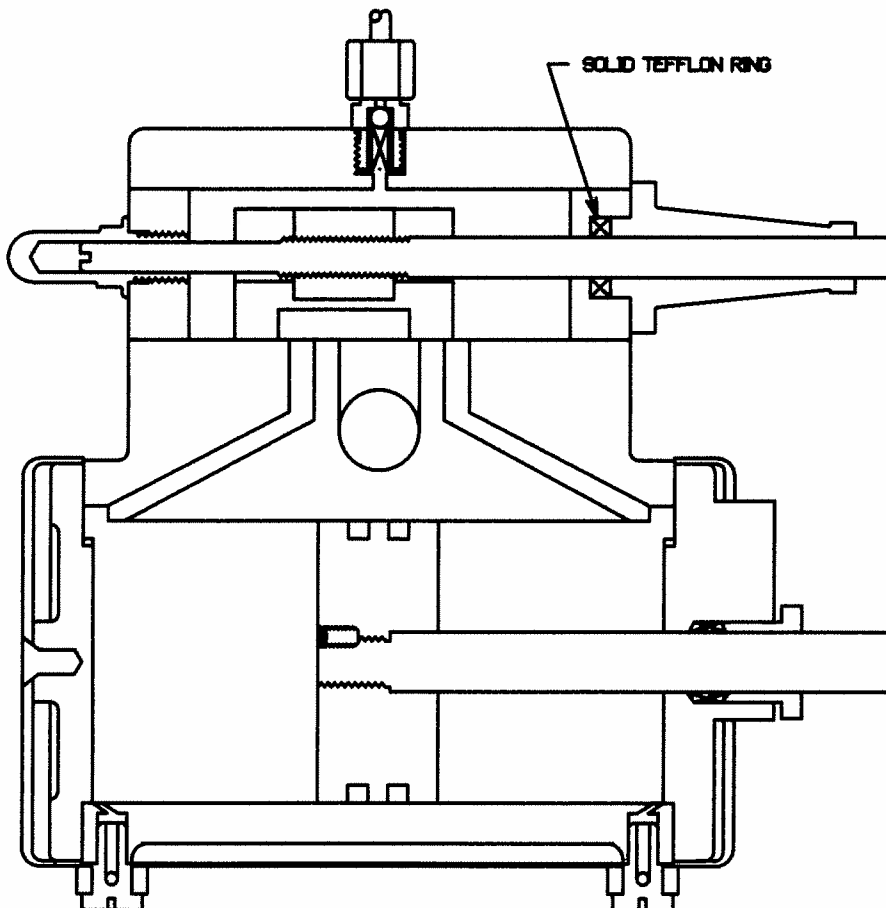
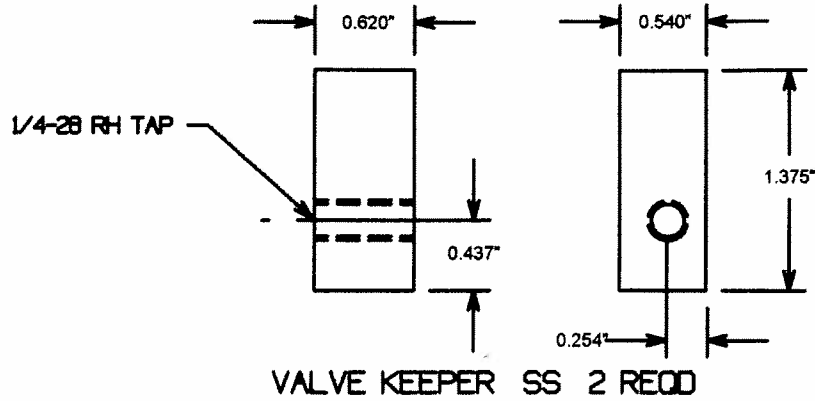
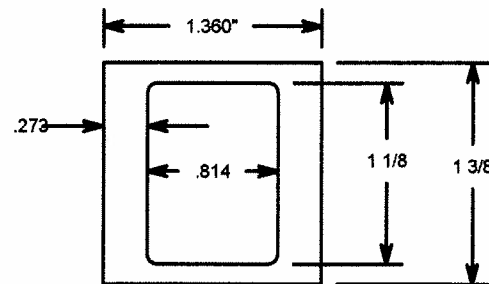
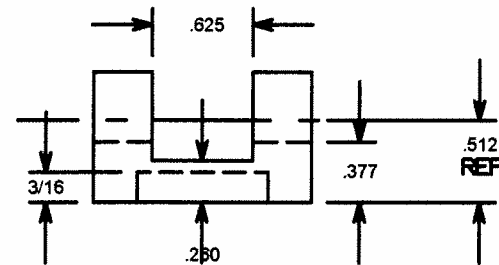
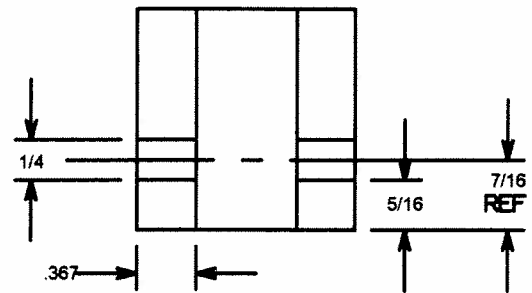

VALVE C.I. 2 REOD

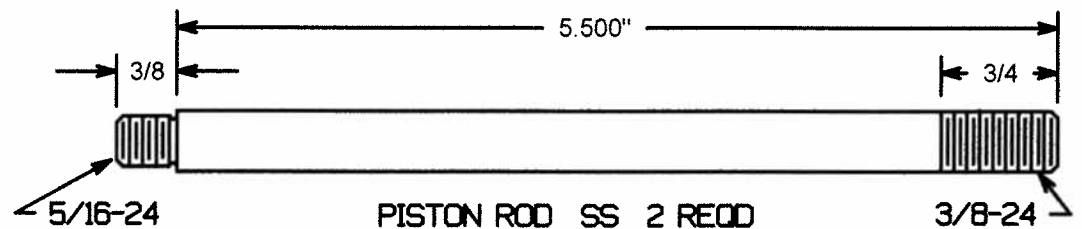

PISTON ROD SS 2 REOD

