

GASKET 2 REQD
TENAX OR EQUIV.

TANK OUTLET 2 REQD
BRASS

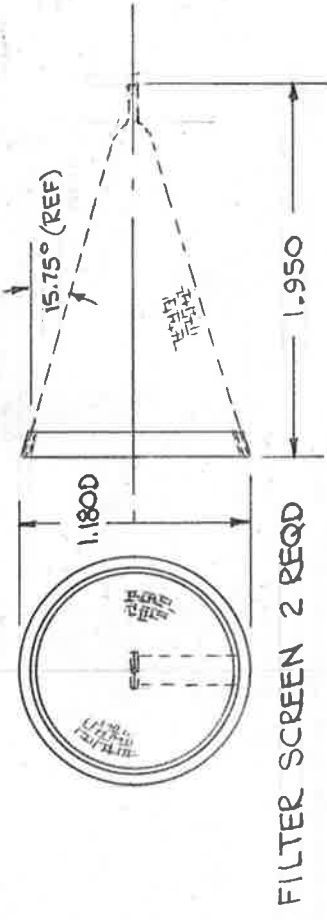

FILTER SCREEN 2 REQD

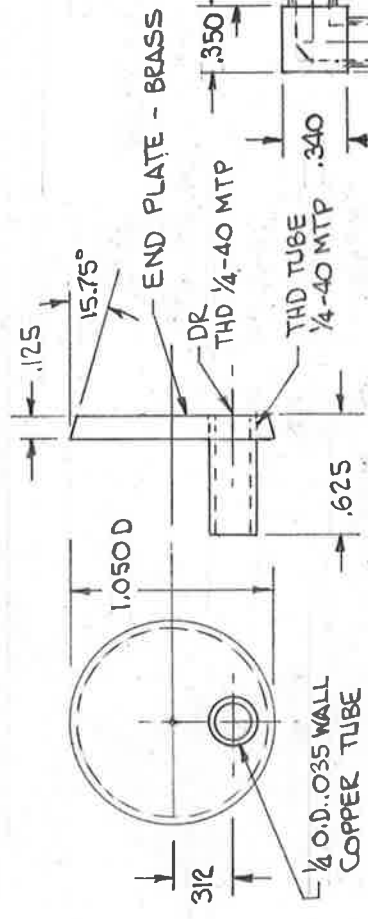

1/4 O.D. x 0.035 WALL
COPPER TUBE

FILTER SCREEN END PLATE 2 REQD
SOLDER TO FILTER SCREEN

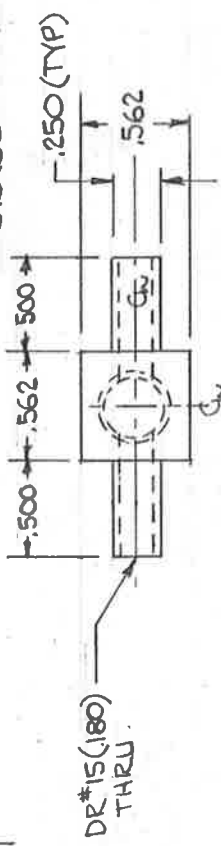

DR #15 (180)
THRU

ELBOW FITTING 1 REQD
BRASS

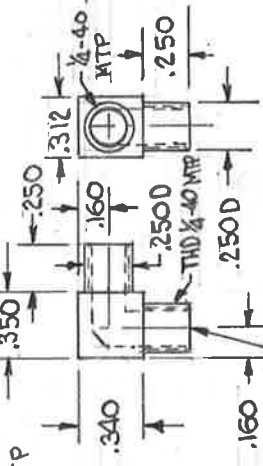

END PLATE - BRASS

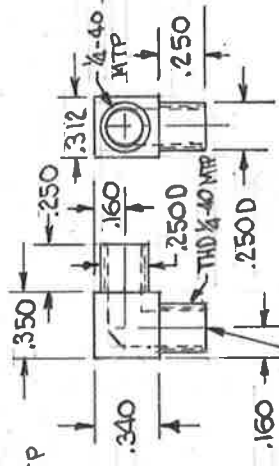

DR THD 1/4-40 MTP

THD TUBE
1/4-40 MTP

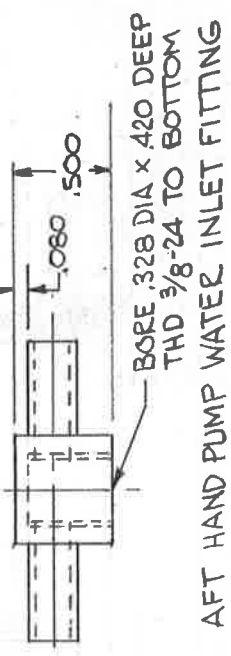

BORE .328 DIA x .420
THD 3/8-24 TO BOTTOM

AFT HAND PUMP WATER INLET FITTING
BRASS 1 REQD

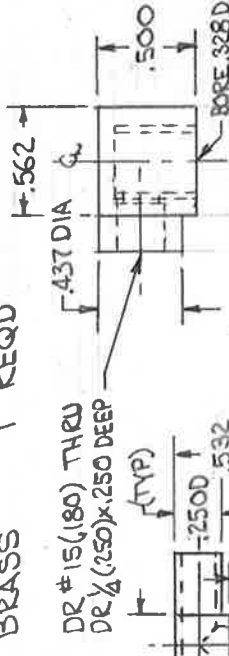

DR #15 (180) THRU
DR 1/4 (250) x .250 DEEP

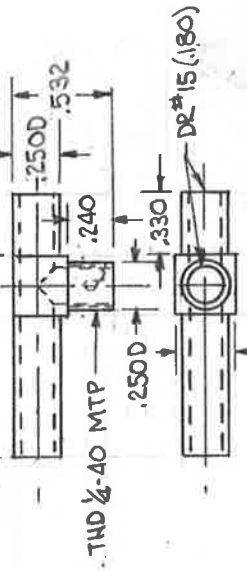

THD 1/4-40 MTP

FWD PUMP FLOW DIVIDER
BRASS 1 REQD

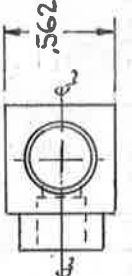

DR #15 (180)

FWD HAND PUMP WATER INLET FTG
BRASS 1 REQD

TENDER WATER SYSTEM DETAILS
B&O P-7 #5300 1" I.D. AKIRE '65