

BRAKE CYL. PIVOT LEVER
STEEL 1 REQD

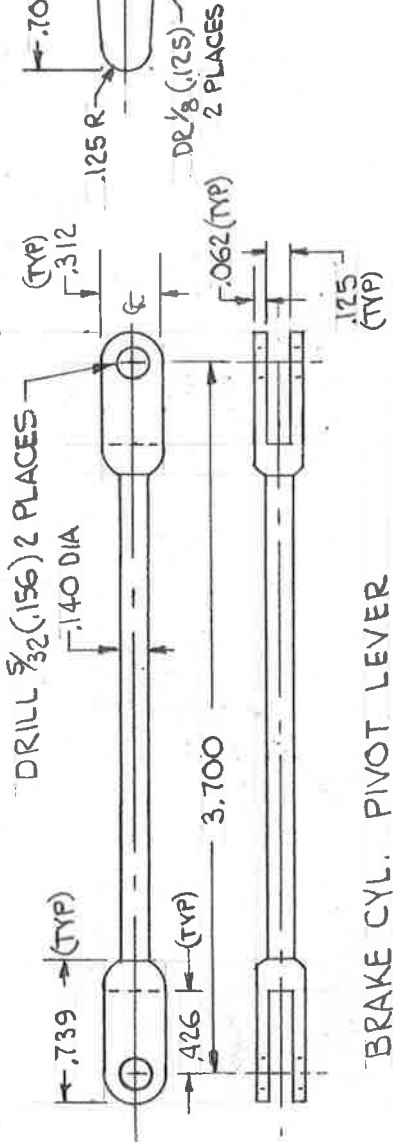

DEAD LEVER GUIDE
4130 STEEL 2 REQD

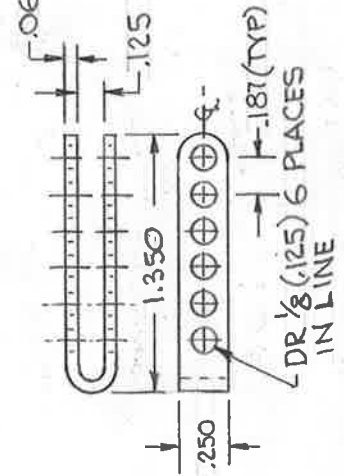

SAFETY STRAP 4 REQD.
STEEL

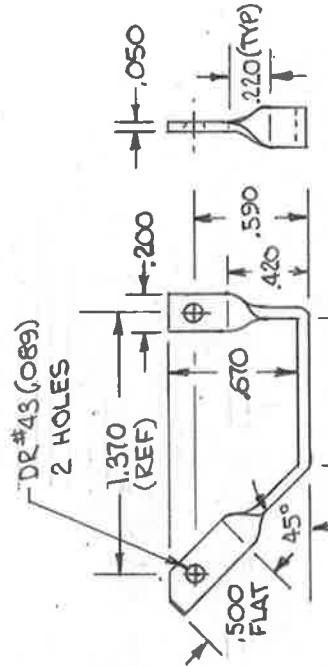

PIVOT PIN
303 STAINLESS STEEL

QUAN	L	D
1	.375	.156
2	.360	.156
16	.360	.125

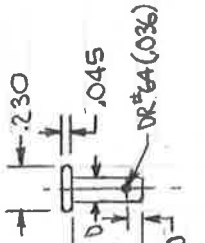

DEAD LEVER GUIDE ADAPTER
L.H. SHOWN R.H. OPPOSITE
STEEL 1 EACH LH & RH REQD.

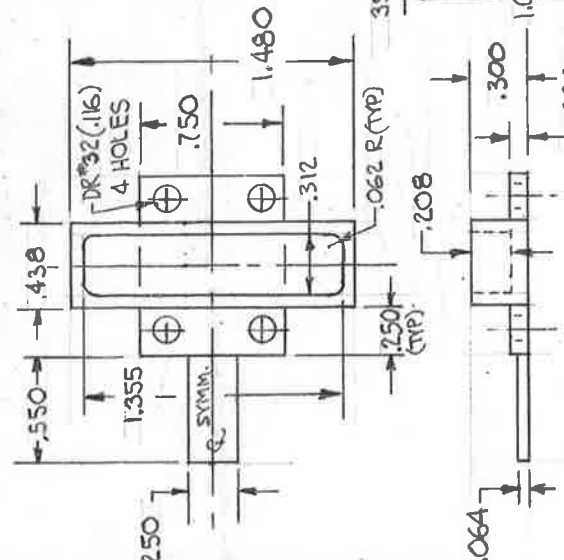

BEARING BLOCK ADAPTER
ALUMINUM 2 REQD

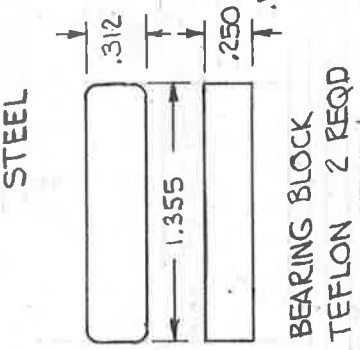

BEARING BLOCK
TEFLON 2 REQD

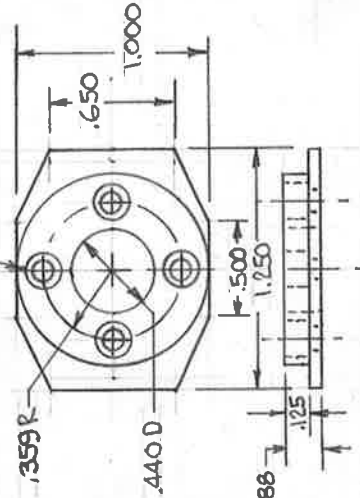

UPPER TRUCK PINOT PLATE
ALUM. ALLOY 2 REQD.

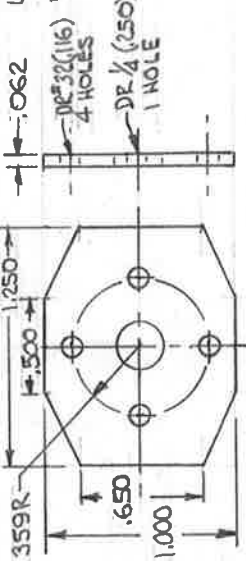

REAR TRUCK UPPER PINOT PLATE SPACER
ALUMINUM 1 REQD.

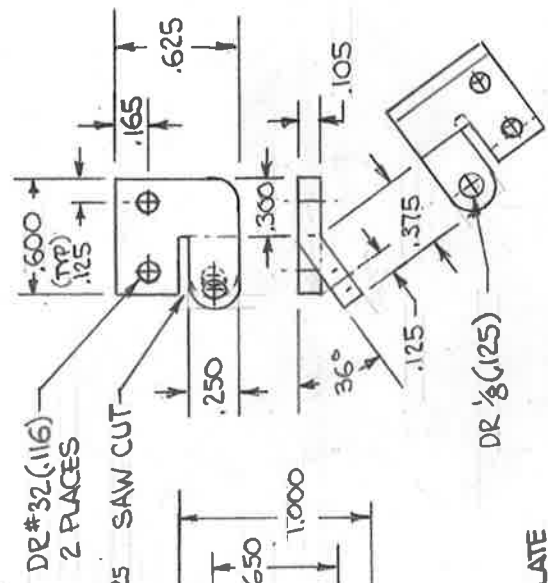

SAW CUT
2 PLACES

TENDER BRAKE DETAILS
B & O P-7 #5300 1"
I.D. ALKIRE 1965