

#1145 EQUALIZER STL. 4 REQD

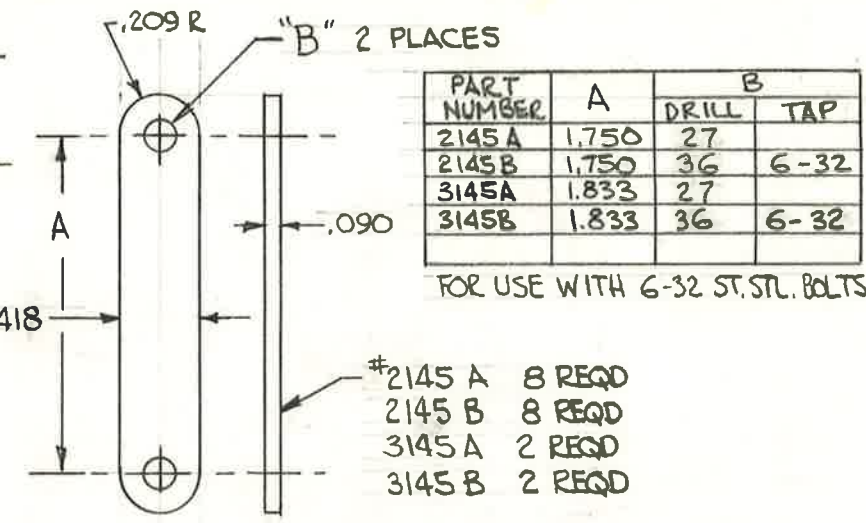

LINK STEEL SEE CHART FOR REQS.

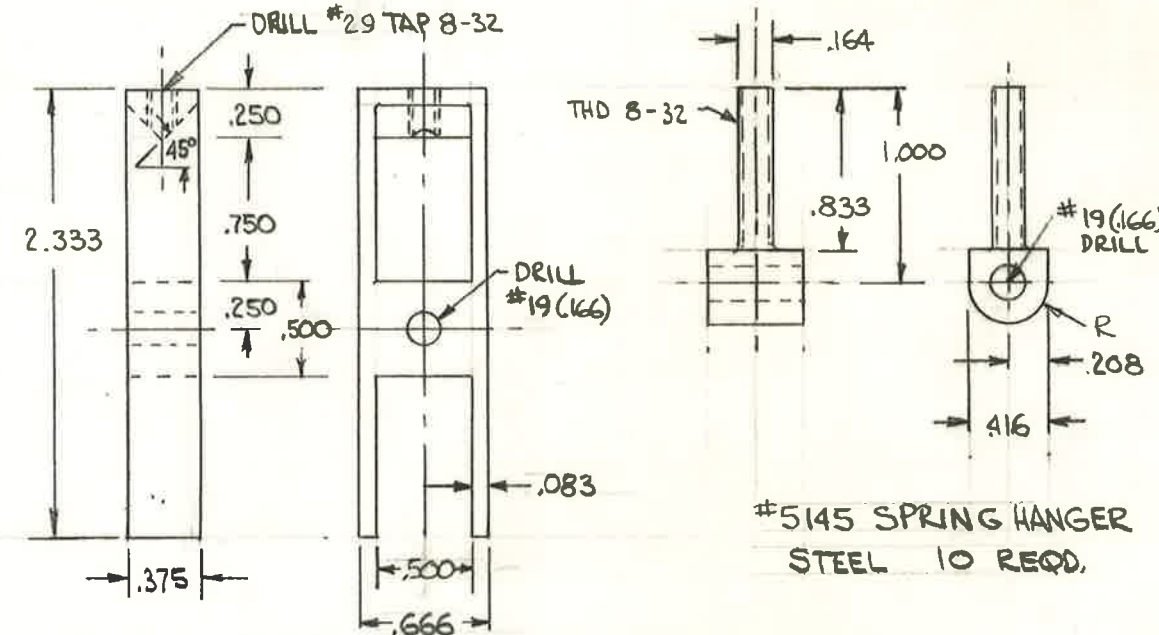

#4145 YOKE HANGER STL 2 REQD

#5145 SPRING HANGER STEEL 10 REQD.

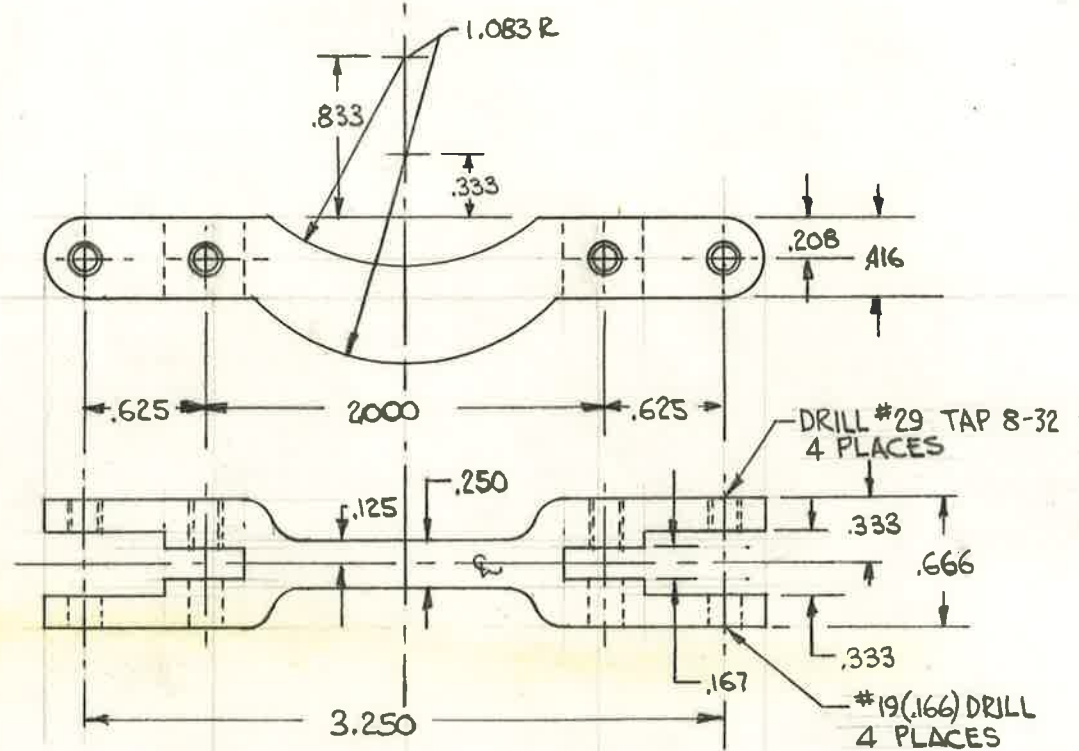

#7145 TRANSVERSE EQUALIZER STL 1 REQD

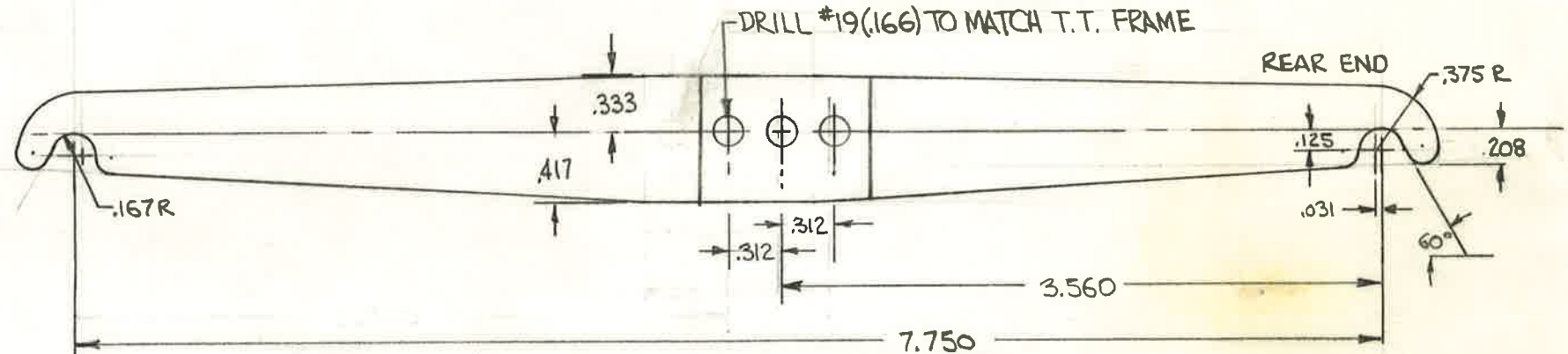

#6145A TRAILER TRUCK EQUALIZER STEEL 2 REQD
 FOR USE WITH LITTLE ENGINES T.T. CASTING
 .250 THICK AT CENTER
 .190 AT ENDS
 UNIFORM TAPER

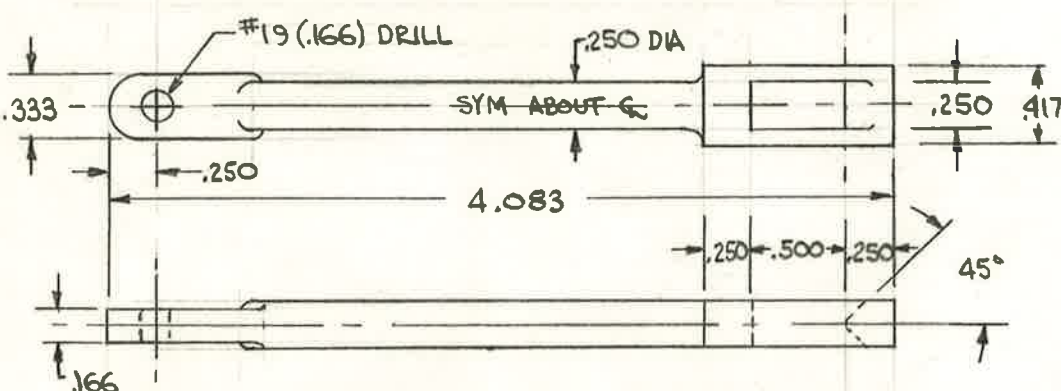

#8145 T.T. HANGER STEEL 2 REQD

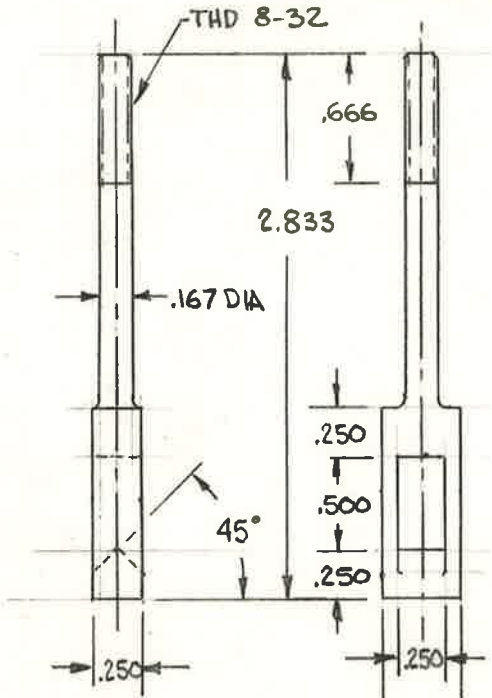

#9145 T.T. HANGER STL 2 REQD

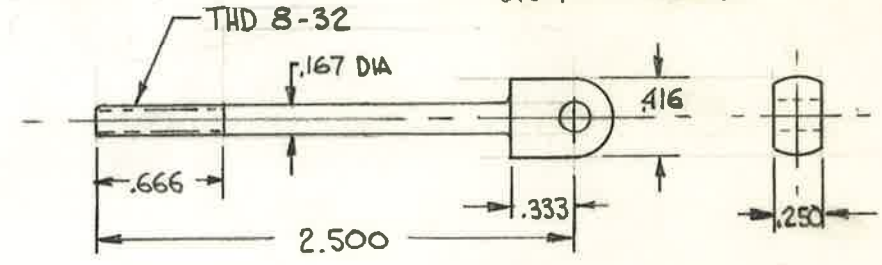

#9145 T.T. HANGER STEEL 2 REQD

B & O P-7 EQUALIZER DETAILS 1"=1'
 I.D. ALKIRE 1962